

# ORTHOPANTOMOGRAPH™ OP 3D Pro

A platform for changing needs



# ORTHOPANTOMOGRAPH™ OP 3D Pro

OP 3D Pro is the most comprehensive 3-in-1 platform designed for today and tomorrow, covering the entire maxillofacial region. OP 3D Pro combines an advanced panoramic imaging system with either cephalometric or cone beam 3D or a combination of both, giving you a truly adaptable platform.

With OP units, each feature is optimized to provide the best possible image quality and efficient clinical use. OP 3D Pro masters the details.



## OP 3D Pro

## OP 2D

### Complete versatility

ORTHOPANTOMOGRAPH™ OP 3D Pro is a platform for changing needs. Depending on the configuration, OP 3D Pro can be upgraded with CBCT or cephalometric modalities.

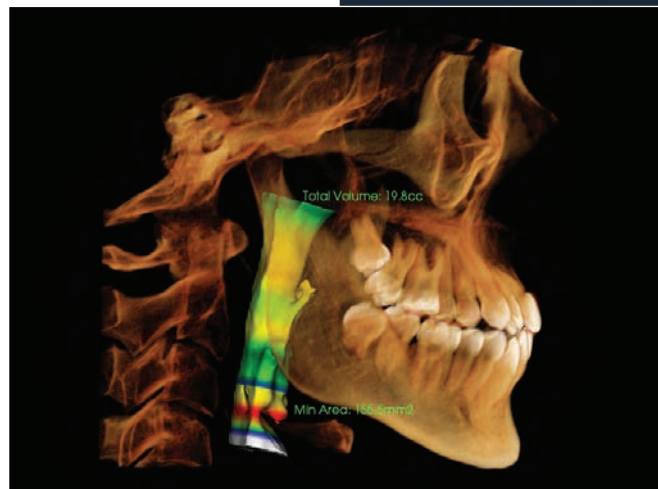

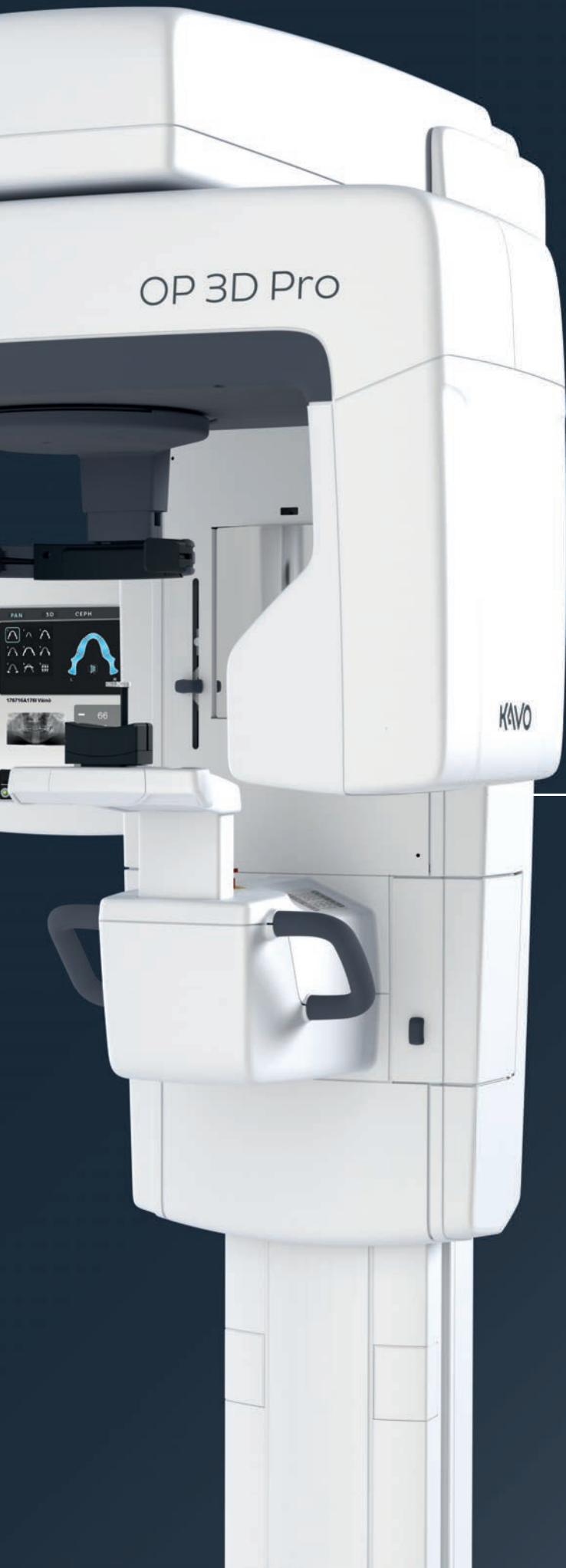

## Excellence for all clinical needs

- General Practitioners
- Endodontics
- Implantology
- Orthodontics
- Oral & Maxillofacial Surgery
- Periodontics
- Prosthodontics
- Airway

# Control without compromise

With ORTHOPANTOMOGRAPH™ units, no usability compromises have been made. The OP 3D Pro system offers ultimate control for obtaining diagnostic information from the correct region of interest. This is achieved with the optimum combination of patient positioning and SMARTVIEW™ scout image.

## SMARTVIEW™ functionality

SMARTVIEW™ functionality FOV positioning accuracy can be verified or adjusted if needed by taking SMARTVIEW™ scout image before CBCT examination. Furthermore, the FOV can be positioned freely to the region of interest, both in horizontal and vertical directions—with ease and confidence.



Even the smallest FOV can be efficiently and precisely positioned with the help of the intuitive user interface and SMARTVIEW™ functionality.

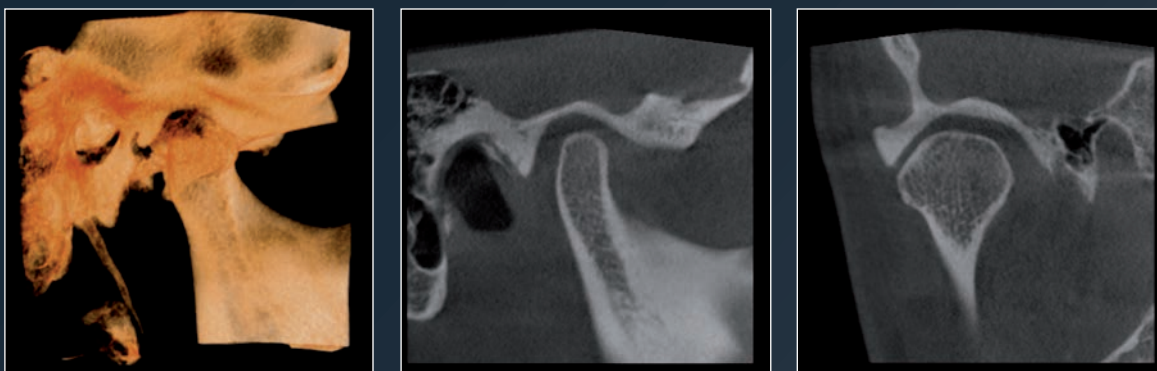

## User-experience in focus

The large, easy-to-use 10" user interface enables intuitive usage and setting of imaging parameters from the very beginning. The result is fast and effortless workflow for all modalities.



# Precision for every patient

3D images provide valuable information vital to diagnosis and determining the best course of treatment. Evaluation of different morphologies is easy as the region of interest can be viewed from all directions.

The precision of OP 3D Pro is founded on the carefully optimized image quality parameters of each program. Both the volume and the resolution can be selected according to the indication and region of interest. OP 3D Pro provides professionals with the tools to succeed.

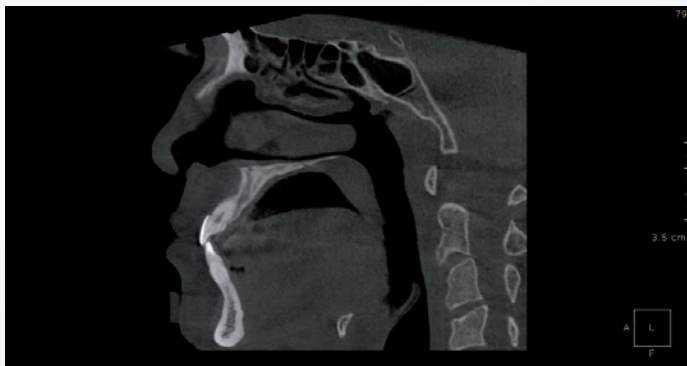

## Automatic Dose Control for 3D

With the proprietary ADC feature, patient-specific exposure settings are obtained automatically providing premium quality images at optimal dose for the patient.

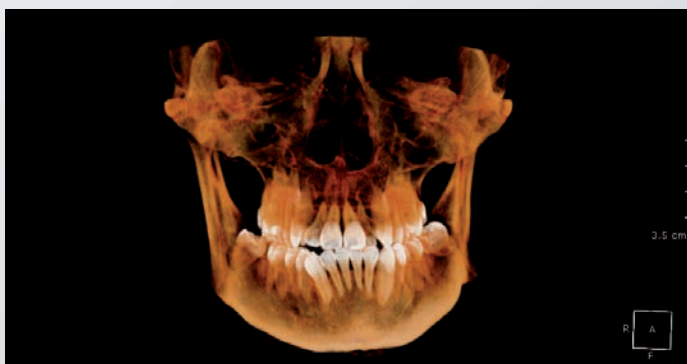

## Resolution for each indication

For each FOV size, it is possible to choose between different resolutions. Additionally, the user selectable Metal Artifact Reduction (MAR) tool can be used with every available FOV.

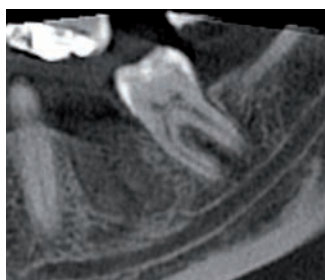

### Low Dose Technology™ scan

(LDT) can be utilized in dose sensitive cases and control or follow-up situations where lower resolution is acceptable.

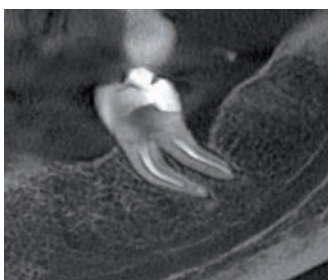

### Standard resolution scan

with optimized patient dose can be used for general diagnostics.

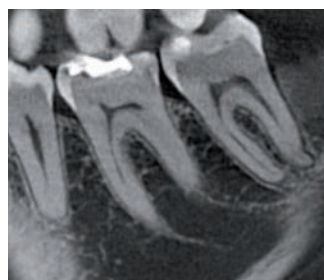

### High resolution scan

offers extremely sharp images for more detailed diagnosis.

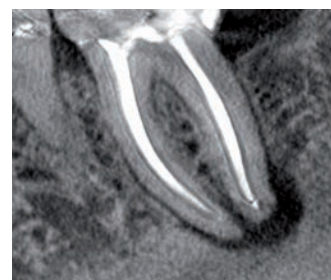

### Endo resolution scan

85 µm voxel size with MAR tool specially designed for endodontic applications. Endo resolution is available for the smallest FOV.

Image quality and patient dose optimized—in all OP 3D Pro programs

# 80%

## Dose Reduction with Low Dose Technology™

OP 3D Pro users have the luxury of using Low Dose Technology™ (LDT), which provides quality optimized low dose scans at up to an 80% reduction in dosing compared to the standard 3D acquisition protocol\* while keeping the clinical value still intact.





## OP 3D Pro small panel

---

### **FOV 6 x 4 cm**

Optimized for single-site implants or localized diagnostics, keeping the patient dose at a substantially reduced level.



### **FOV 6 x 8 cm**

Covers the complete dental arch for multiple implant placement and allows for the use of surgical guides.



## OP 3D Pro

---

### **FOV 5 x 5 cm**

Optimized for single-site implants or localized diagnostics, keeping the patient dose at a substantially reduced level.



### **FOV 8 x 15 cm**

Covers both mandibula and maxilla including airway and upper cervical spine or the sinus. Both TM joints can also be studied.



### **FOV 6 x 8 cm**

Covers the complete dental arch for multiple implant placement and allows for the use of surgical guides.



### **FOV 13 x 15 cm**

Covers the entire maxillofacial region.



### **FOV 8 x 8 cm**

Covers the entire dentition, including both mandibula and maxilla as well as a portion of maxillary sinus.



# Clinical images

FOV 13x15 cm

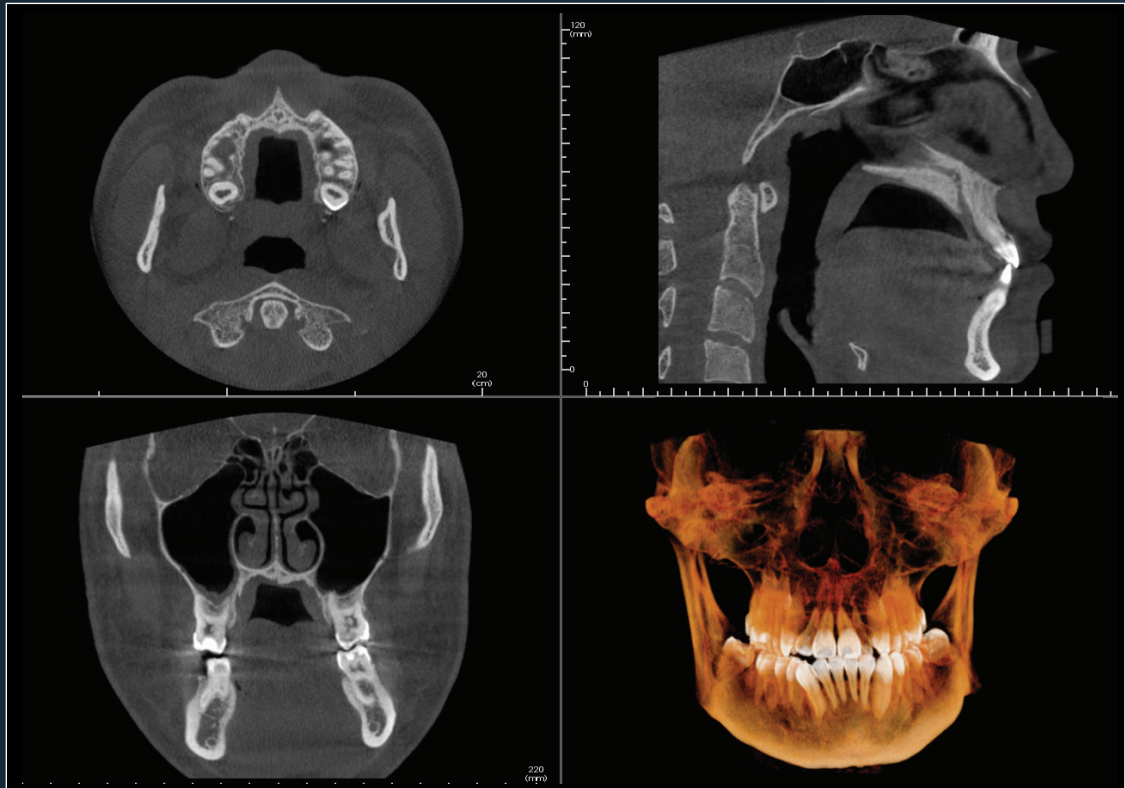

FOV 8x15 cm

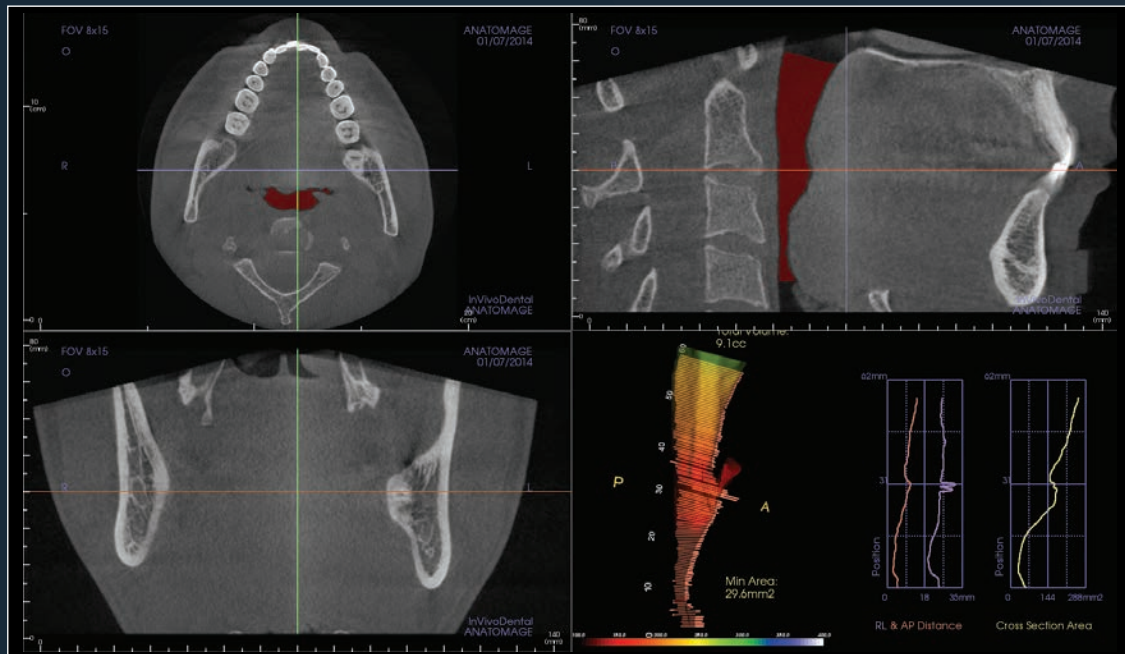

FOV 8x8 cm

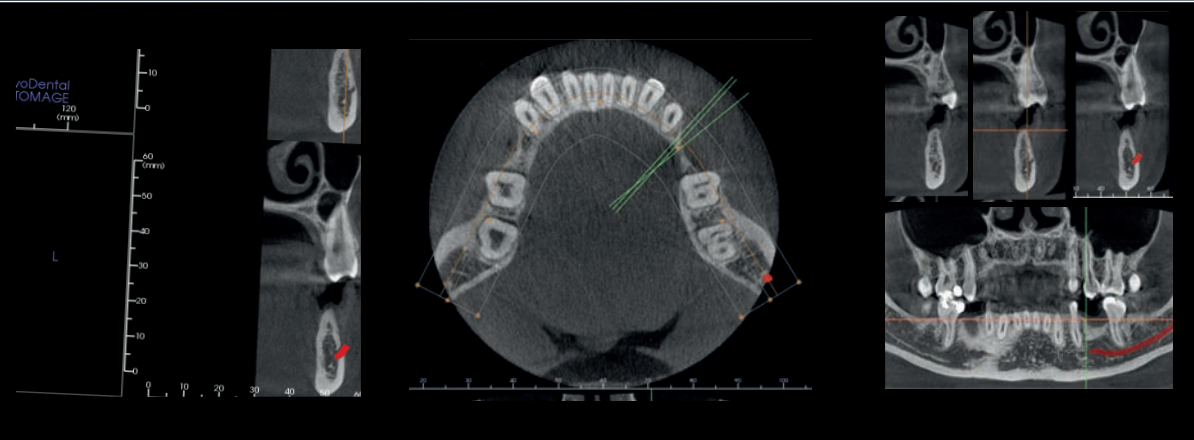

FOV 6x8 cm

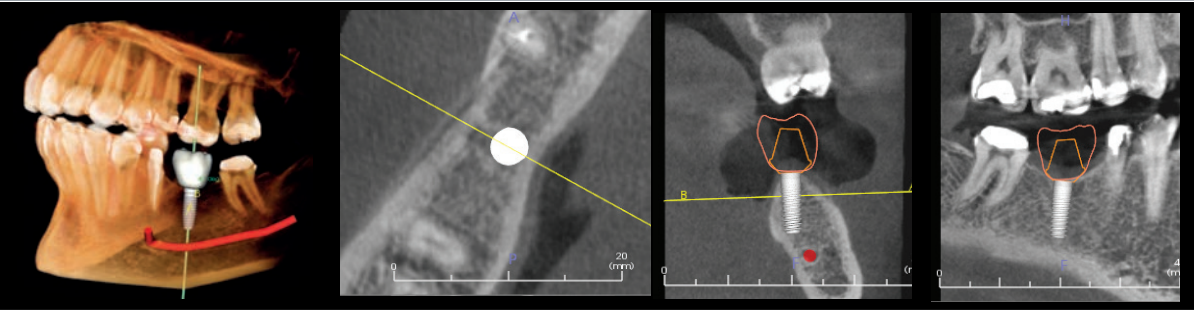

FOV 5x5 cm

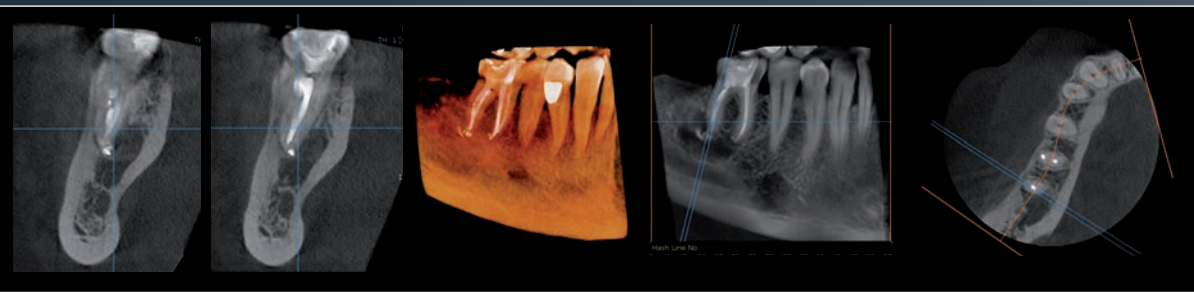

FOV 6x4 cm

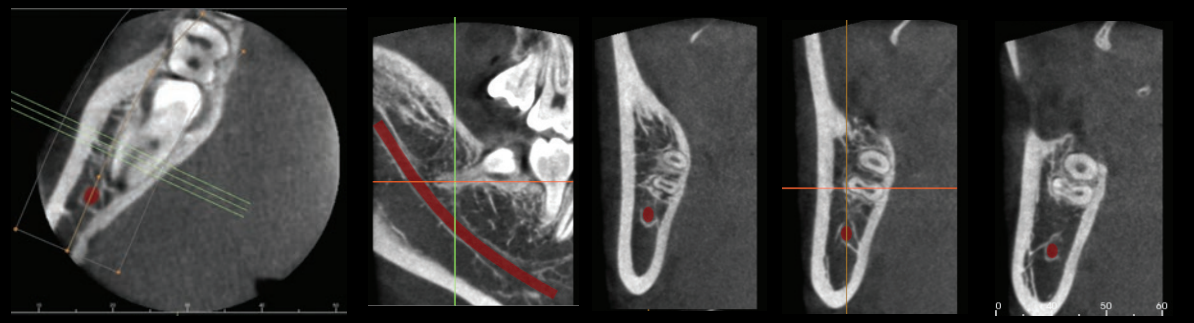

# OP 3D Pro panoramic: Perfection brings confidence

Consistent, repeatable, gold-standard image quality offers the power to diagnose quickly and efficiently with a wide range of panoramic imaging programs. The unique combination of dedicated panoramic sensor, ADC, easy patient positioning and the best possible imaging geometry provide excellent diagnostic images—time after time.

## **Automatic Dose Control (ADC)**

Proprietary ADC technology automatically optimizes panoramic exposure levels for each patient and every acquisition, resulting in patient-specific dosage and enhanced workflow efficiency.

## **Multilayer pan**

The OP 3D Pro multilayer feature provides five panoramic images with only one scan to compensate for incorrect patient positioning and difficult anatomies—all achieved in the same scanning time and dose as the traditional panoramic scan.

## **ORTHOfocus™ feature—sharp images automatically**

With the user-selectable ORTHOfocus™ feature, optimum panoramic layer is provided automatically and every time.



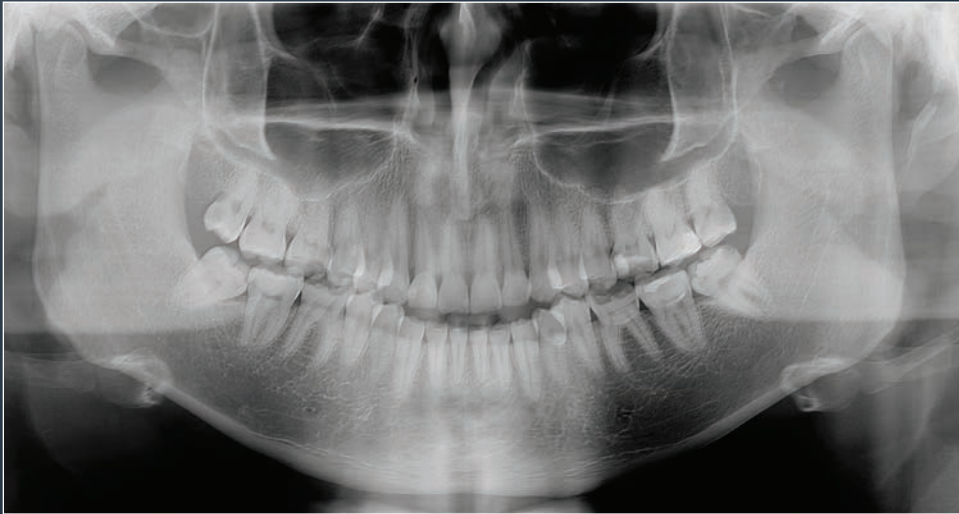

The standard adult panoramic imaging program provides clear and consistent image.



The pediatric panoramic program has a clinically adapted image layer and reduced images height.



Bitewing-like view is a quick and easy alternative to intraoral bitewing imaging.

# OP 3D Pro cephalometric: Unsurpassed results

A variety of cephalometric imaging programs are available for OP 3D Pro. Furthermore, it can be tailored to your preferences. The cephalometric arm can be positioned to either side for optimum use of space and user-experience.

## **Excellent image quality for every patient**

Automatic Facial Contour (AFC) automatically decreases the exposure values during the scan for better soft tissue definition in the facial region.

## **Adjustable scanning area**

Fully adjustable scanning area ensures that by exposing only the required region, the patient dose is decreased.

## True 3-in-1 platform



Cephalometric

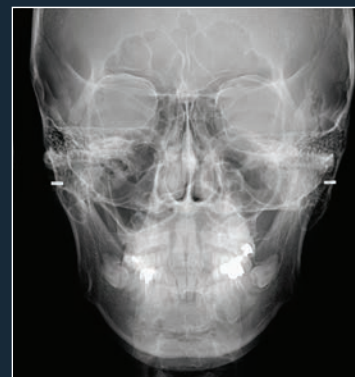

Cephalometric PA

# Cliniview™

## Fast and accurate diagnosis

The CLINIVIEW™ software is specifically designed for your workflow. Image storage and processing, as well as diagnostic decisions, treatment planning and printing, are built to function intuitively. The main focus is on extreme fluency of use for fast, accurate diagnoses. CLINIVIEW™ software is highly compatible and connected. Utilizing the industry-standard DICOM format, images can be transported between CLINIVIEW™ software and a wide range of other sources, including TWAIN.

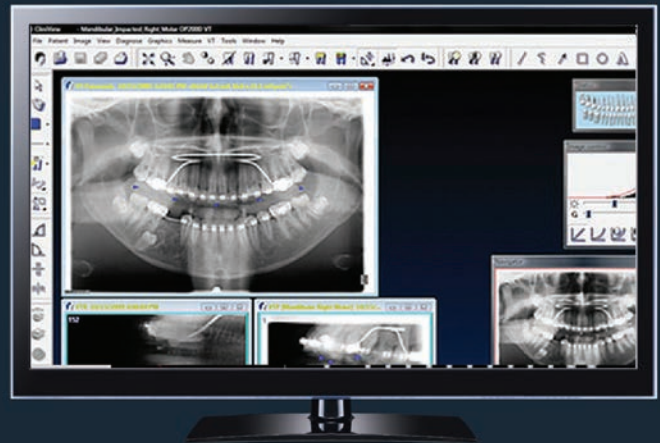

# Invivo™

## Powered by Anatomage

The software is incredibly powerful, yet intuitive, which helps doctors concentrate on treatment planning versus the tool itself. Clinicians have so much control in implant selection and placement. They can adjust and size the implant directly in the 3D rendering, design the crown and abutment and perform the surgery virtually. The software also helps clinicians create accurate treatment plans for ortho, endo, oral surgery and restorative cases. The potential to treat different cases is enormous.



# Leading the way through the decades

For more than 50 years, the name of ORTHOPANTOMOGRAPH™ system has stood for ultimate reliability and clinically correct maxillofacial imaging.

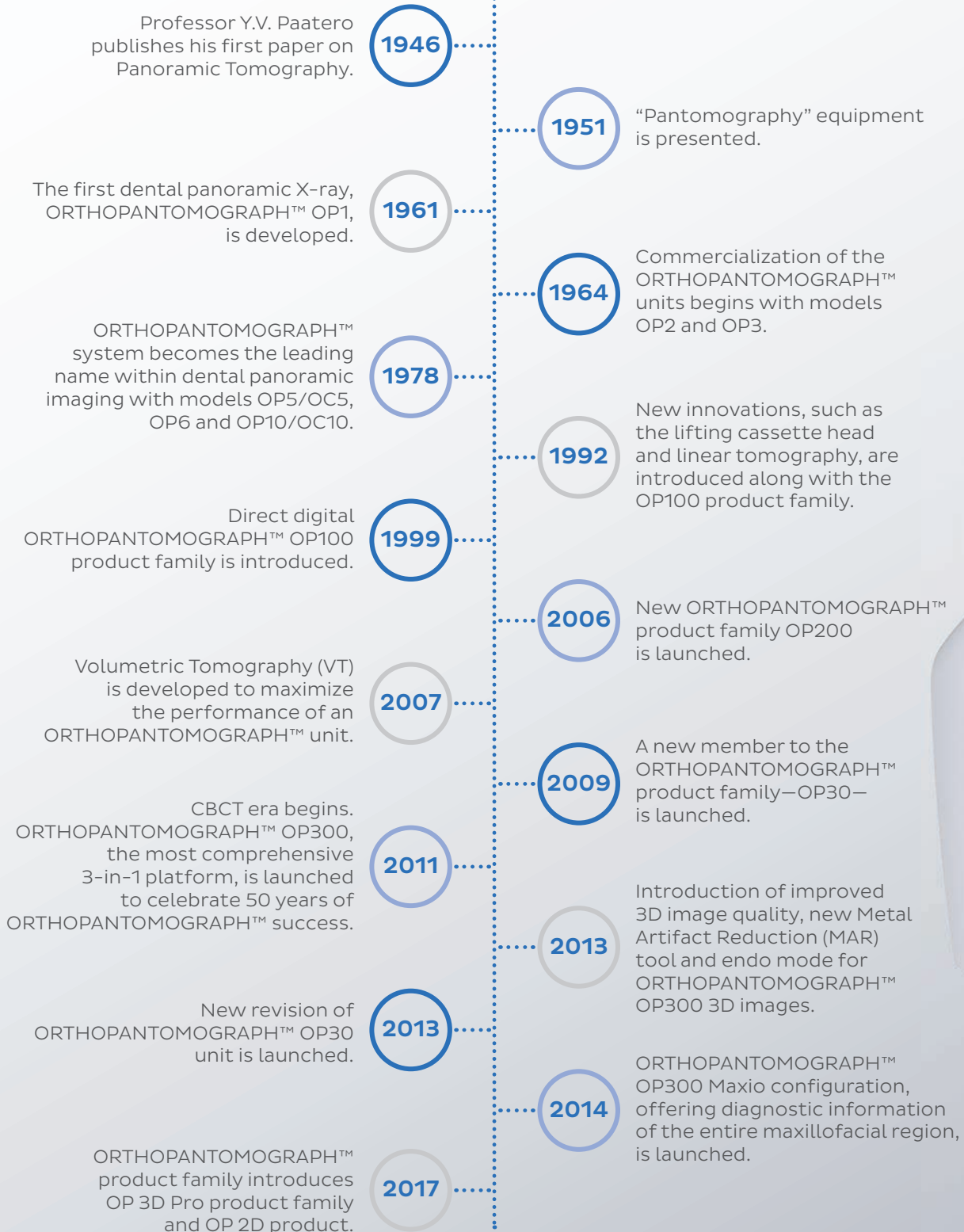



## KaVo—Dental Excellence

KaVo is committed to providing the foundation so our customers can do more of what is important to them. Through product innovation, world-class service and exceptional support, KaVo brings the best dental technology—from Gendex, Instrumentarium Dental, NOMAD, and SOREDEX—together as one.

The known KaVo quality is now available in an impressive product portfolio. We are proud to offer handpieces, treatment units and world-class imaging solutions and more.

**Everyday, we are empowering clinicians to do more of what matters.**



KAVO

OP 3D Pro

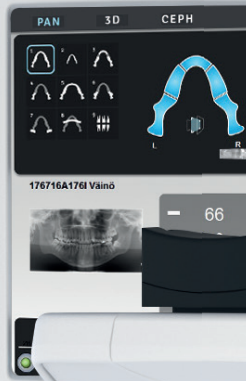

# Technical Specifications

Focal Spot	0.5 mm, IEC 336
Tube Voltage	57-90 kV
Tube Current	3.2-16 mA
HU Capacity	35 kJ, 49 000 HU
Minimum Total Filtration	3.2 mm Al
Wheelchair accessible	Yes

2D	Panoramic	Cephalometric
Image Detector	CMOS	CMOS
Sensor Pixel Size	100 µm	100 µm
Image Pixel Size	100 µm	100 µm
Scan/Exposure Time	8.6-16.1 s	10-20 s
Image Field Height	148 mm	170 mm-260 mm
Imaging Programs	Standard, Pediatric, Ortho Zone, Orthological, Wide Arch, Lat TMJ, PA TMJ, Maxillary Sinus, Bitewing	
Weight	200 kg/440 lbs	250 kg/551 lbs

3D	OP 3D Pro small panel	OP 3D Pro
Image Detector	CMOS	CMOS
Image Voxel Size	85 µm-330 µm	85 µm-420 µm
Scan Time	11-21 s	11-42 s
Exposure Time	1.2-12.6 s	1.2-8.7 s
Image Volume Sizes (HxW)	61x41, 61x78 mm	50x50, 61x78, 78x78, 78x150, 130x150 mm
DICOM Support	Yes	Yes
Min. room height	2050-2450 mm	2050-2450 mm

## Minimum System Requirements for 3D Acquisition Workstation

CPU (processor)	Intel Core i5, i7 or Xeon, 4-cores or more
GPU (graphics processing unit)	NVIDIA Quadro M2000 4GB or GeForce GTX 1050 Ti 4GB
RAM (memory)	8 GB or more
Storage (hard disk)	1 TB or more RAID 1 or RAID 5 recommended for data redundancy, plus backup
Network	Gigabit Ethernet 1000 Mb/s
Operating System	Windows 10 Pro or Enterprise, 64-bit Windows 8.1 Pro or Enterprise, 64-bit Windows 7 Professional, Ultimate or Enterprise, 64-bit, with SP1
Display	1920 x 1080 resolution (Full HD) or higher, at least 300 cd/m2 brightness for typical room lighting, native contrast ratio 100:1 or better, 8-bit panel strongly recommended
Other	OpenCL 1.1 support DVD-ROM drive Anti-virus software
Notes	Please refer to software and device installation manuals for detailed requirements

## Unit Dimensions

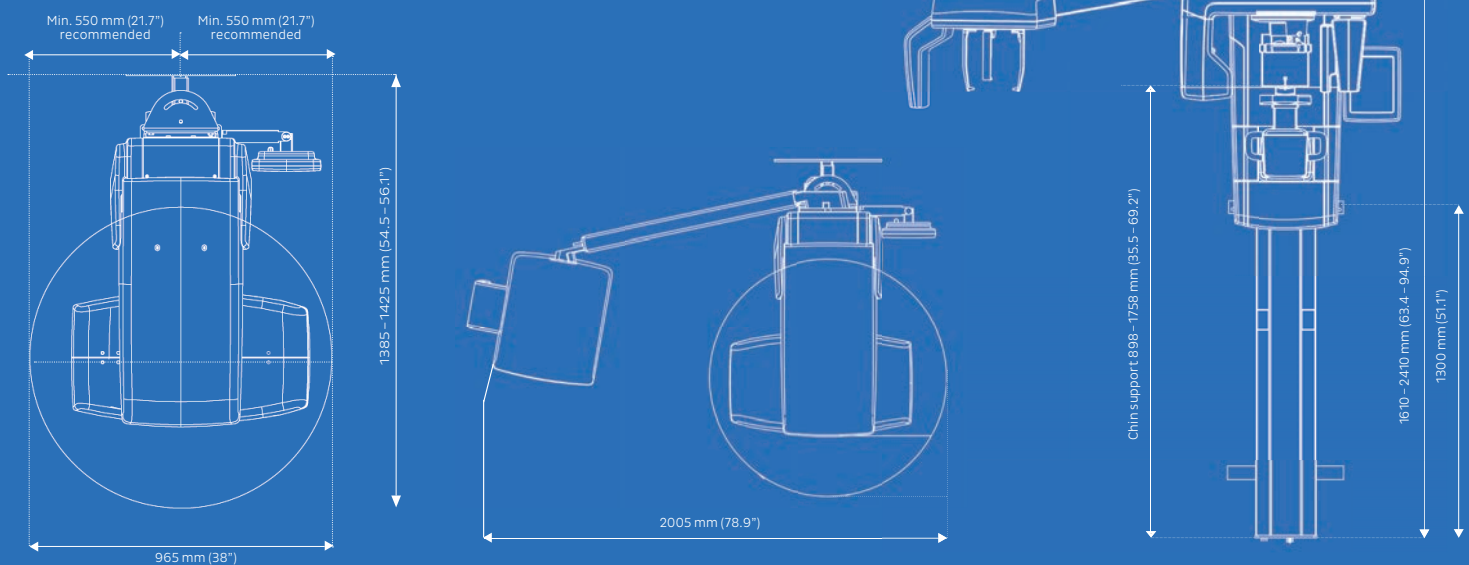

# Dental Excellence from KaVo.



## Handpieces

KaVo has always been the leader in creating innovative solutions for dental practitioners. Our vast line of quality handpieces showcase our attention to your level of care while delivering performance that lasts.



## Treatment Units

Beautiful lines, patient comfort and simple operation are just a few of the benefits to the line of KaVo treatment units. Everything you need to perform any procedure— all in one solution.



## Imaging Solutions

Designed with ease-of-use for all clinicians in mind, KaVo now offers dependable and consistent imaging solutions that provide vital information to support accurate diagnosis and predictable treatment planning.

The products, equipment and services illustrated and described in this brochure reflect knowledge at the time of printing. KaVo Dental accepts no liability for any deviation from the illustrations in terms of color or shape, or any errors or print errors, and retains the right to make changes to the brochure at any time. Full or partial reprinting is only permitted with permission from KaVo Dental. For indications for use, please visit: [www.kavo.com/us/ifu](http://www.kavo.com/us/ifu).

KaVo Kerr Group Finland reserves the right to make changes to specifications and features shown herein, or to discontinue the Product described at any time without notice or obligation. Contact your local authorized representative for the most current information. CE marked according to Medical Device Directive (NB 0537). Electrical safety according to IEC 60601-1. Operations comply with ISO 13485:2003, ISO 9001:2008, and ISO 14001:2004. Manufactured by Palodex Group OY, Nahkelantie 160, 04300 Tuusula, Finland.

ORTHOPANTOMOGRAPH™ / OP™ / SMARTVIEW™ / CLINIVIEW™ / Low Dose Technology™ / ORTHOfocus™ are either registered trademarks or trademarks of KaVo Kerr Group Finland in the United States and/or other countries. KaVo™ is either registered trademark or trademark of Kaltenbach & Voigt GmbH in the United States and/or other countries. All other trademarks are property of their respective owners.

© 2017 KaVo Dental. All rights reserved. KV00009/B3.17